

Well-Qualified  
And Confirmed By

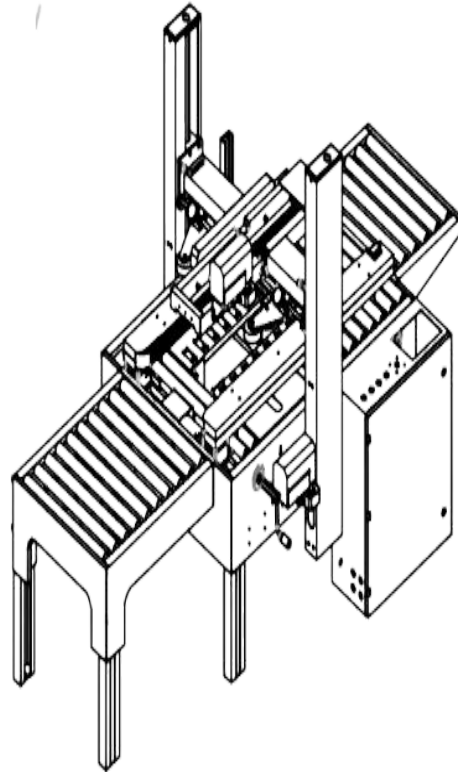

Well-Qualified  
And Confirmed By

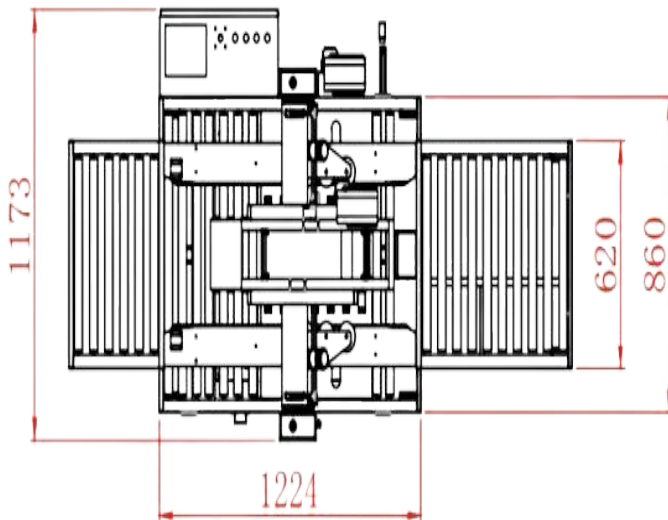
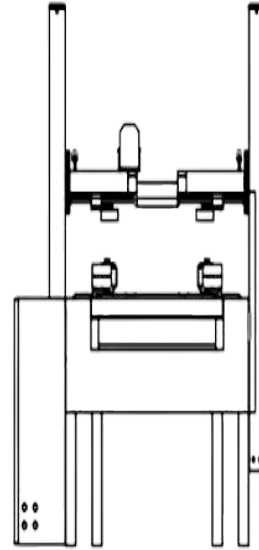
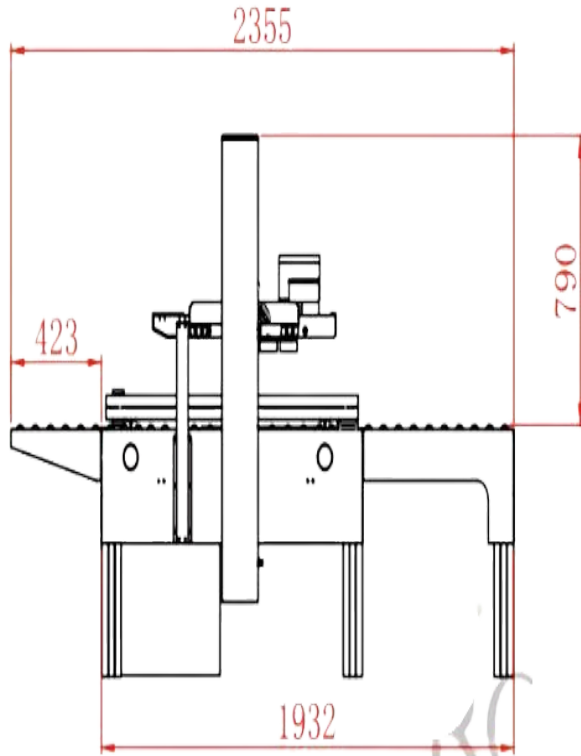

Well-Qualified  
And Confirmed By



www.royal-packings.com

## REINFORCED PAPER TAPE Paper Tape for Packaging

This Water-Activated Kraft Box Tape delivers a quality and firm seal for many different types of products.

ROYAL  
ROYAL PACKING

## PRODUCT ADVANTAGES



### Automatic sealing can be used to seal different size cartons

Say goodbye to manual packing cumbersome processes, automatic control of sealing boxes of different sizes of cartons, a machine all done

### Height and width can be adjusted

Can be adjusted according to the situation to suit your different needs



Well-Qualified  
And Confirmed By

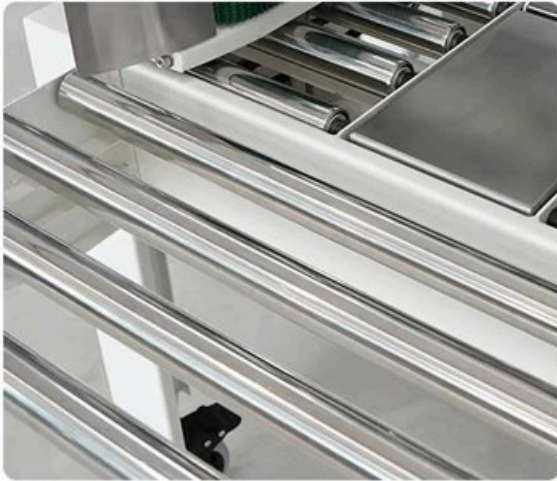

### Thickened stainless steel roller

The use of stainless steel conveying process is more stable longer service life

It can be matched with express labeling machine to achieve assembly line express packing

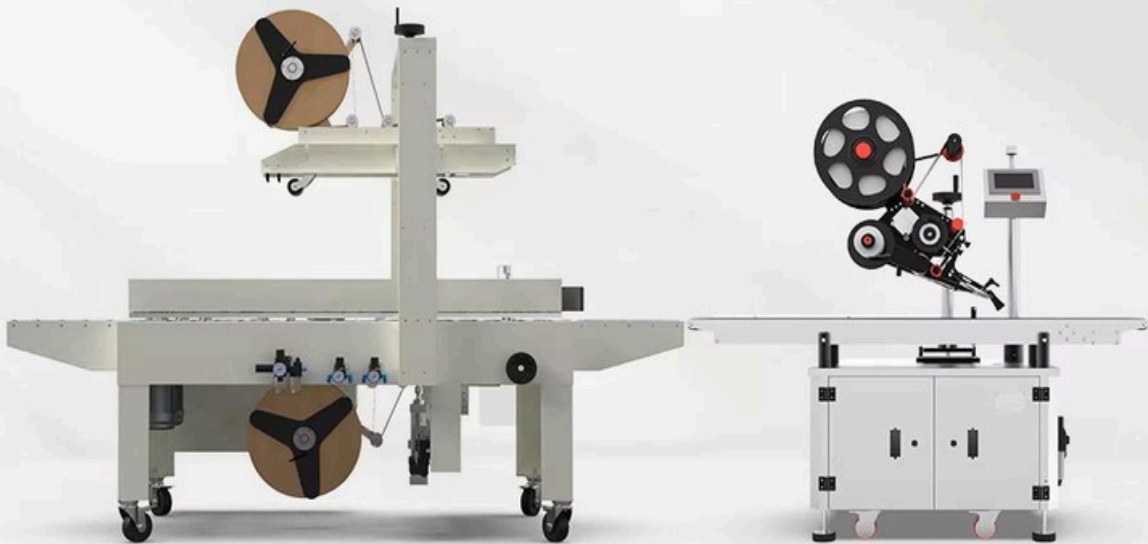

The sealing box labeling completes the assembly line operation at onetime, eliminating the need to solve your packaging efficiency problems

Well-Qualified  
And Confirmed By

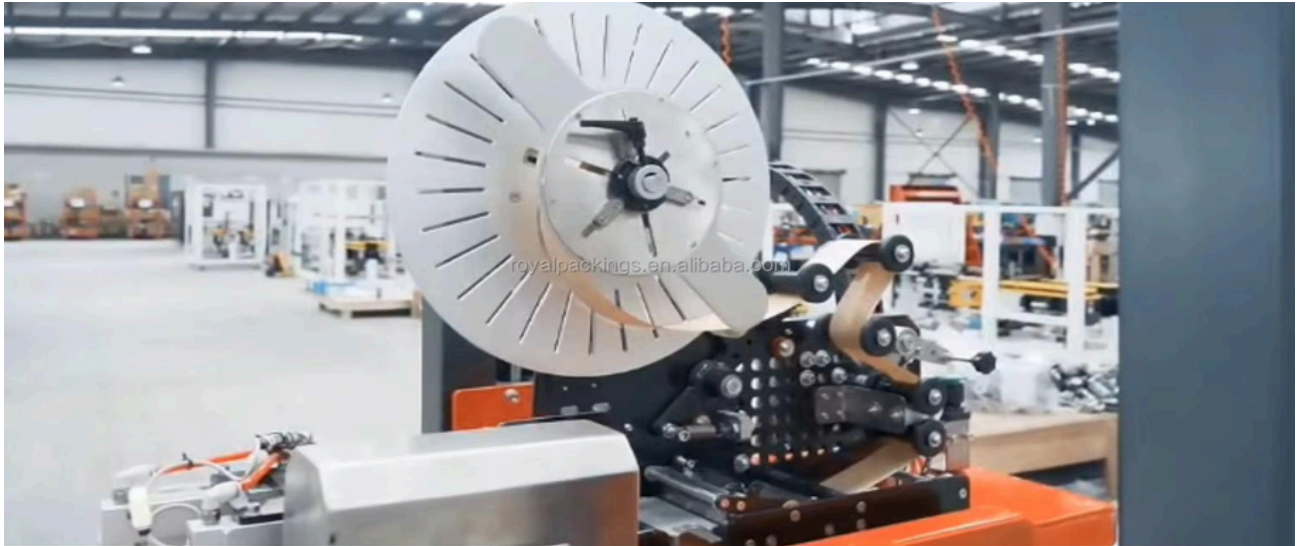

Well-Qualified  
And Confirmed By

